

Fitting Instructions for bi-parting doors up to 100kg each.

For a pair of bi-parting doors up to 1250mm wide each, operating on a Husky 100 system only.
Door thickness between 25mm and 50mm.

Tools required

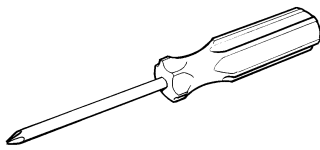

1 x Phillips screwdriver

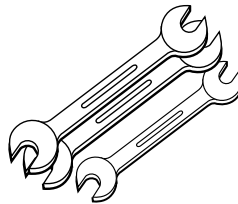

2 x 8mm Spanners
1 x 7mm Spanner

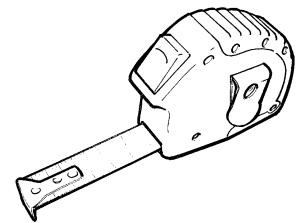

1 x Tape measure

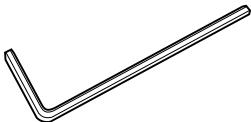

1 x Allen Key - 5mm



1 x Drill + 2mm drill bit
(for drilling pilot holes on top of doors)

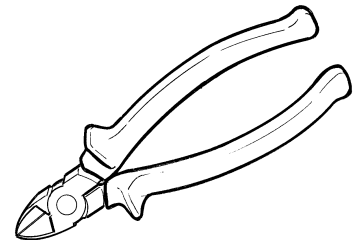
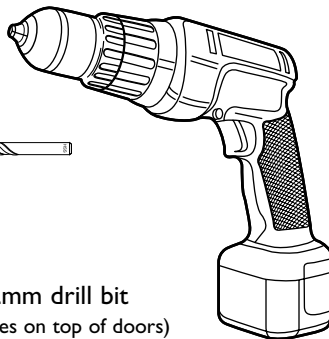

1 x Cable cutters

1. Install the Husky 100 system for two bi-parting doors in accordance with the instructions (supplied in the Husky kit) ensuring that the doors have been fitted correctly and are sliding freely, and the clip stops are secured at the door opening limits.
2. Remove the last bolt from both end clips, and replace with the extended bolt complete with the pulley assembly to both of the clip stops. See diagrams 1 and 2.
3. Disconnect both of the doors from the sliding gear and fit the left and right hand door brackets to the top of both the doors in a central position, and 5mm off the centre of the door thickness using the screws provided, see diagram 5. Then re-hang the doors as before.
4. Taking the cable (ensuring it is 'kink' free), hook the fixed loop end of the cable to the right hand door bracket as shown in diagram 4.
5. Feed the cable through the right hand pulley wheel. Ensure that the cable travelling in and out of the pulley runs parallel, see diagram 2.
6. Place the Cable Collar into the left hand door bracket, and thread the cable through the collar as shown in diagram 3. Do not tighten the grub screws at this stage.
7. Feed the cable through the left hand pulley wheel. Ensure that the cable travelling in and out of the pulley runs parallel, see diagram 1.
8. Whilst holding the cable with a small amount of tension thread the Cable Clamp on to the cable. Then form a loop and insert the thimble into the loop. Feed the end of the cable back through the Cable Clamp to hold the shape of the loop, see diagram 4.
9. Fit the Adjuster Bolt on to the right hand door bracket complete with the two Lock Nuts, then hook the Spring on to the Adjuster Bolt and hook the cable loop on to the other end of the Spring, see diagram 4.
10. Pull the excess cable through the Cable Clamp until the spring starts to pull back, and then tighten the cable clamp nut with the 7mm spanner to secure the cable loop. Cut off any excess cable with the cable cutters.
11. Using the 8mm spanners adjust the Adjuster Nut to tension the cable so there is no sag in the cable and lock off the Lock Nut.
12. Position the doors so that they are centralised within the opening, and tighten the grub screws in the Cable collar to secure the doors in place. Test the operation of the system to ensure it is working correctly.

Diagram 1.

Left hand clipstop and pulley assembly

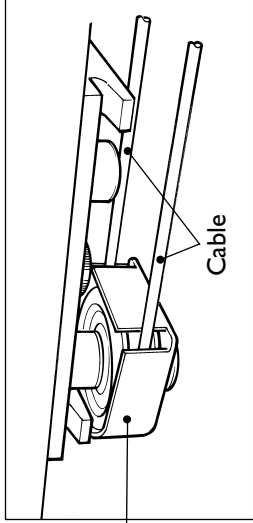

Clipstop end bolt removed and replaced with extended bolt, spacer and pulley assembly

Cable

Diagram 2.

Right hand clipstop and pulley assembly

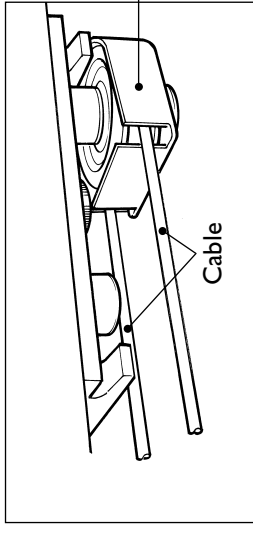

Clipstop end bolt removed and replaced with extended bolt, spacer and pulley assembly

Cable

Elevation view of system

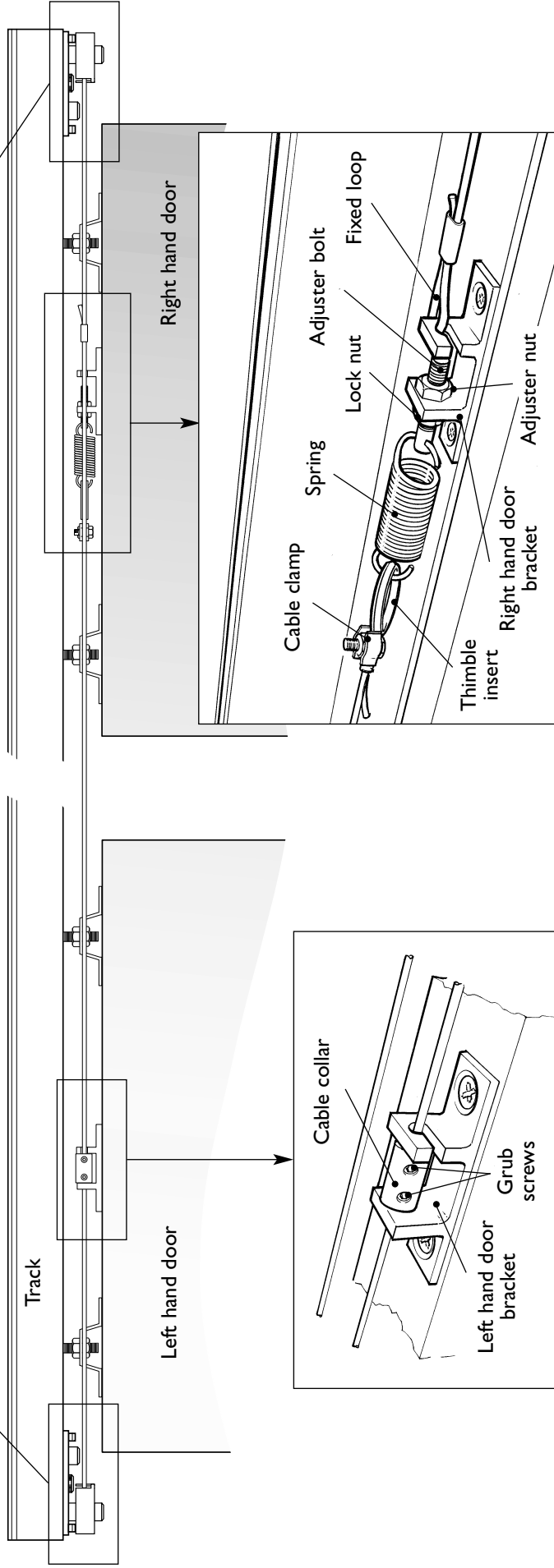

Cable collar

Left hand door bracket

Grub screws

Cable clamp

Spring

Lock nut

Adjuster bolt

Fixed loop

Thimble insert

Right hand door bracket

Adjuster nut

Diagram 3.

Cable anchored to left hand door

Diagram 4.

Cable anchored to right hand door, tensioning and adjustment bolt.

5mm

5mm

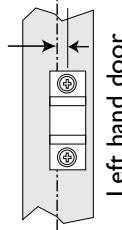

Centre Line of doors

Left hand door

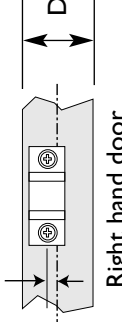

Door thickness

Right hand door

Diagram 5.